

Frequency Range	698-960x2 1710-2690x4
Polarization	±45°
Half-Power Beam Width	65°
Electrical Downtilt	2° - 12°x 6

Type **DOD7-2B4J-RF65**

Base Station Antenna

12-ports 698-960 / 698-960 /1710-2690 /1710-2690 /1710-2690 /1710-2690 MHz 65°, 15 / 15 / 17 / 17 / 17 / 17 dBi, 2°-12° / 2°-12° / 2°-12° / 2°-12° / 2°-12° / 2°-12° Tilt Antenna With 6 Integrated RCUs.

Electrical Specifications

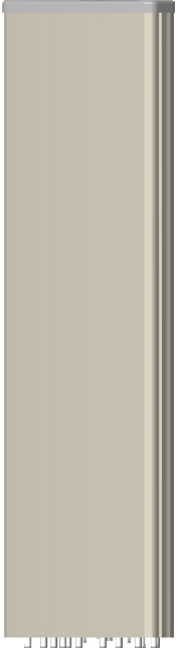

Frequency Range(MHz)		2x698-960		4x1710-2690		
		698-894	880-960	1710-1920	1920-2180	2490-2690
Polarization		±45°				
Horizontal 3dB Beamwidth(°)		68±5	60±5	62±5	68±5	63±5
Vertical 3dB Beamwidth(°)		10±1.5	8.6±0.7	11±0.8	9.5±1.0	8.0±1.0
Gain (dBi)		14.7±0.5	15.2±0.5	15.6±0.5	15.8±0.5	16.6±0.5
Electrical Downtilt		2°-12°		2°-12°		
Upper Sidelobe Suppression(dB)	First	≥16	≥16	≥17	≥17	≥17
Front-to-Back Ratio Total Power, ±30° (dB)		≥25	≥25	≥25	≥25	≥25
Cross polar ratio	Main direction(dB)	≥17	≥17	≥18	≥18	≥18
	±60° (dB)	≥8	≥8	≥8	≥8	≥8
Isolation ports(dB)		≥25				
Isolation Frequency(dB)		≥28				
VSWR		< 1.5				
Intermodulation IM3		< -153 dBc(2x43dBm carrier)				
Impedance		50 Ω				
Max. Power per Input (at 50°C ambient temperature)		500 W		300 W		
Lightning Protection		DC Ground				

Mechanical Specifications

Radome Material	Fiberglass
Connector Type and Location	4.3-10x12 ,Bottom iRCU in:1 x 8 pin male iRCU out:1 x 8 pin female
Dimensions,HxWxD(mm)	1995 x 446 x 165
Packing Size(mm)	2210 x 535 x 270
Weight ,w/o Mounting kit(kg)	29
Weight w/ Downtilt Bracket(kg)	36
Packing Weight (w/ Downtilt Bracket) (kg)	42
Max. Wind Velocity(mph)	150
Mounting hardware	Φ 50 mm ~ Φ 115 mm
Operational Temperature(°C)	-40 to +65
Operational Humidity(%)	<95
Wind Load at 100mph (Frontal/lateral/Rearside(N))	1230/240/1295

Frequency Range	698-960x2 1710-2690x4
Polarization	±45°
Half-Power Beam Width	65°
Electrical Downtilt	2° - 12°x 6

Type DOD7-2B4J-RF65

Integrated RET Properties

RET Type	6 x Type 1 Single RET	
Protocols	Compliant to AISG 2.0/3GPP	
Input voltage range	+10~+30VDC(pin 6)	
Power consumption	<2W(stand by);<13W(motor activated)	
Connectors	AISG	2 x 8 pin connector acc. To IEC 60130-9 Acc.to AISG Daisy chain in:male Daisy chain out:female
	Antenna	Two motor shaft(Embedded motor)
Hardware interface	AISG	RS485A/B(pin5/pin3);Power supply(pin6); DC return(pin7)Acc.to AISG
Adjustment time(full range)	40 sec(typically,depending on antenna)	
Adjustment Cycles	≥10000	
Torque Max	≥160mN.m	
Lightning Protection Rating	IEC 61000-4-5 Current Pulse Profile,8/20 μs 10 Repetitions Min.@ 6kA IEC 61312-1 Annex B Current Pulse Profile, 10/350 μs,200 Repetitions Min. @ 0.6kA	

COMPREHENSIVE TILT CONFIGURATION

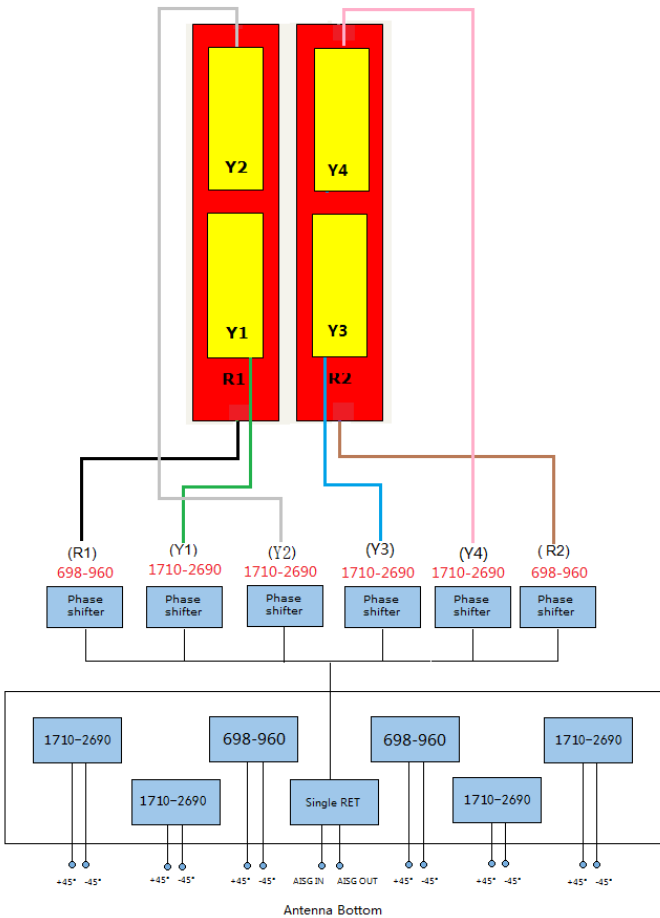

Frequency Range	Array	RET Unique ID
698-960MHz	R1	NDPMXXXXXXXX-7090R1
698-960MHz	R2	NDPMXXXXXXXX-7090R2
1710-2690MHz	Y1	NDPMXXXXXXXX-1727Y1
1710-2690MHz	Y2	NDPMXXXXXXXX-1727Y2
1710-2690MHz	Y3	NDPMXXXXXXXX-1727Y3
1710-2690MHz	Y4	NDPMXXXXXXXX-1727Y4

Note: (1) Physical RET Unit containing (6) Single RET

Frequency Range	698-960x2 1710-2690x4
Polarization	±45°
Half-Power Beam Width	65°
Electrical Downtilt	2° - 12°x 6

Type DOD7-2B4J-RF65

Radiation Pattern (698 - 824 MHz)

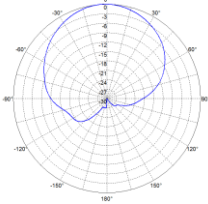

Horizontal Pattern

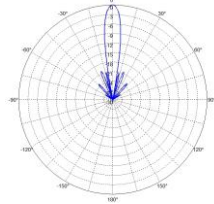

Vertical Pattern

Radiation Patterns (824 - 894 MHz)

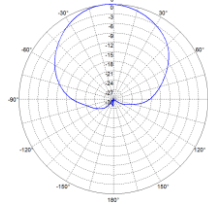

Horizontal Pattern

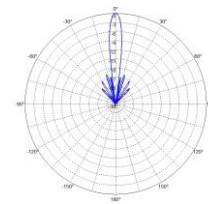

Vertical Pattern

Radiation Pattern (1710 - 2180 MHz)

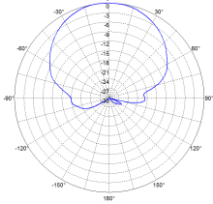

Horizontal Pattern

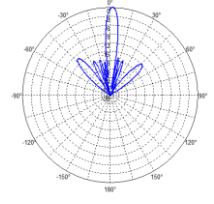

Vertical Pattern

Radiation Patterns (2300 - 2400 MHz)

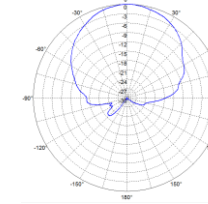

Horizontal Pattern

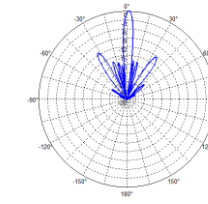

Vertical Pattern

Radiation Pattern (2490 - 2690 MHz)

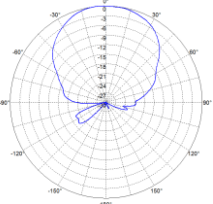

Horizontal Pattern

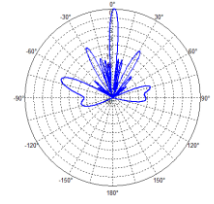

Vertical Pattern